

FUTURA 2P

ALUMINIUM IT'S IN OUR DNA



EZ-FIT

PT Dobradiça em alumínio para perfis de canal europeu. Sistema EZ-FIT permite rápida instalação no perfil. Disponível com ou sem regulação. Fiel em inox 304. Calços com dentado especial para evitar deslizamento.

ES Bisagra en aluminio para perfiles de canal europeo. Sistema EZ-FIT permite una rápida instalación en el perfil. Disponible con o sin regulación. Eje en inox 304. Contrachapas con dentado especial para evitar deslizamiento.

UK Aluminium hinge for european groove. EZ-FIT system, that allows an easy installation in the profiles. Available with or without regulation. 304 stainless steel axel. The back plates are incorporated with a special serration in order to avoid slipping.

FR Paumelle en aluminium pour profils de gorge européenne. Avec le système EZ-FIT qui permet une installation rapide et facile de la paumelle dans le profil. Axe en acier inox. Les platines incorporent un denté spécial pour éviter le glissement.

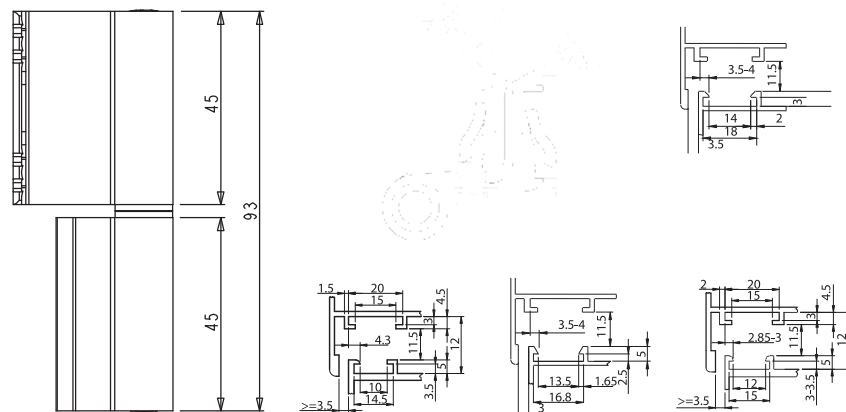

FUTURA 2P T-SPEC

ALUMINIUM IT'S IN OUR DNA



EZ-FIT

PT Dobradiça em alumínio para perfis de canal europeu. Recomendada para elevadas forças transversais. Fiel em inox 304. Sistema EZ-FIT para uma instalação rápida no perfil. Os calços apresentam um dentado especial para evitar deslizamento.

ES Bisagra en aluminio para perfiles de canal europeo. Desarrollada para soportar cargas elevadas. Eje en acero inox 304. Sistema EZ-FIT para una instalación rápida en el perfil. Las contrachapas presentan un dentado especial para evitar el deslizamiento.

UK Aluminium hinge for european groove. Developed for heavy-duty work. Axel in stainless steel 304. Recommended for where there are large transversal forces. EZ-FIT system for an easy installation in the profiles. The back plates are incorporated with a special serration in order to avoid slipping.

FR Paumelle en aluminium pour profils de gorge européenne. Recommandée quand il a grands efforts transversaux. Développé pour supporté charges élevées. Avec le système EZ-FIT, qui permet une installation rapide et facile de la paumelle dans le profil. Axe en acier inoxydable 304. Les platines incorporent un denté spécial pour éviter le glissement.

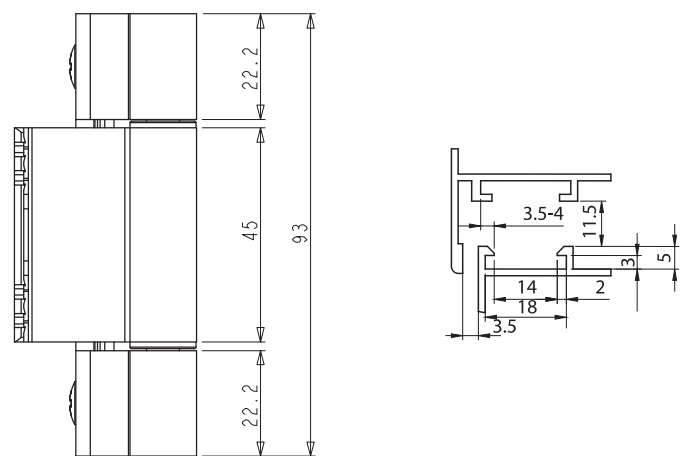

FUTURA



ANC.COM.0002.001/A-0115

FUTURA 7100

ALUMINIUM IT'S IN OUR DNA

PT Dobradiça em alumínio para séries de câmara europeia. Desenvolvida para suportar cargas elevadas. Fiel em inox 304. Regulação 3D.

ES Bisagra en aluminio para canal europeo. Desarrollada para soportar cargas elevadas. Eje en inox 304. Regulación 3D.

UK Aluminium hinge for european groove. Developed to support heavy weight. 304 stainless steel pin. 3D regulation system.

FR Paumelle en aluminium pour gorge européenne. Conçu pour résister à des charges élevés. Axe en inox 304. Réglage 3D.

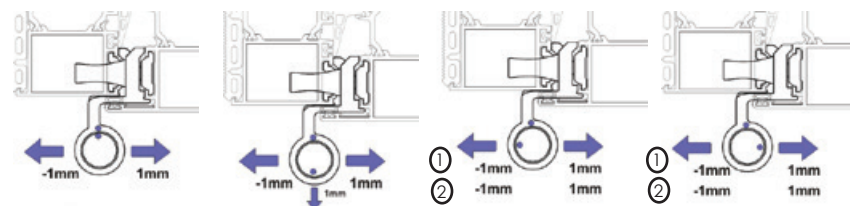

1. Bucha / Taco / Nylon Cap/ Douille
2. Fiel / Eje / Axel/ Axe

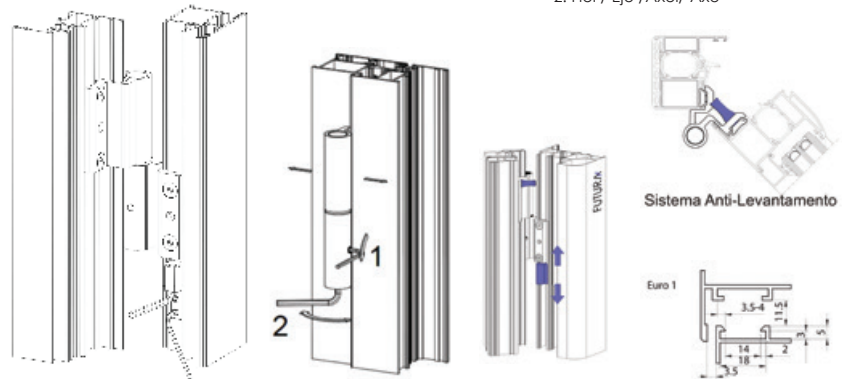

Sistema Anti-Levantamento

Euro 1

FUTURA 8100

ALUMINIUM IT'S IN OUR DNA

PT Dobradiça em alumínio para séries de câmara europeia. Desenvolvida para suportar cargas elevadas. Fiel em inox 304. Perno central de segurança. Regulação 2D.

ES Bisagra en aluminio para canal europeo. Desarrollada para soportar cargas elevadas. Eje en inox 304. Perno central de seguridad. Regulación 2D.

UK Aluminium hinge for european groove. Developed to support heavy weight. 304 stainless steel pin. Central grub screw. 2D regulation system.

FR Paumelle en aluminium pour gorge européenne. Conçu pour résister à des charges élevés. Axe en acier inox 304. Réglage 2D.

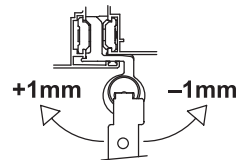
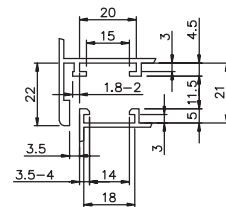
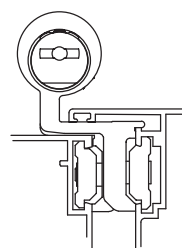
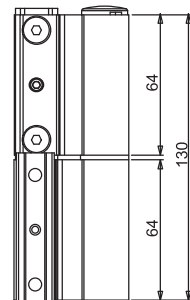
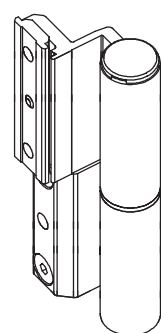

FUTURA 8100 SPEC

ALUMINIUM IT'S IN OUR DNA

PT Dobradiça em alumínio para perfis de canal europeu. Dobradiça de 3 corpos para assegurar a mais elevada performance aos mais exigentes requisitos. Fiel em inox 304, perno de segurança. Regulação 2D.

ES Bisagra en aluminio para perfiles de canal europeo. Bisagra de 3 cuerpos para asegurar la mejor respuesta a los requisitos más exigentes. Eje en acero inox. Perno de seguridad. Regulación 2D.

UK Aluminium hinge for european profiles. 3 body aluminium hinge, specially developed to ensure the best performance in the most demanding situations. Stainless steel axle and security pin. 2D regulation.

FR Paumelle en aluminium pour gorge européenne. 3 lames, développé pour garantir la plus haute performance pour les applications les plus exigeantes. Axe en inox. Système de réglage 2D.

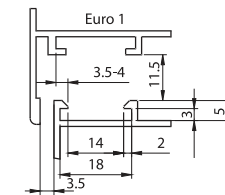
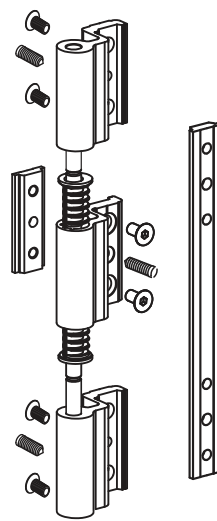

FUTURA 8100 T-SPEC

ALUMINIUM IT'S IN OUR DNA

PT Dobradiça em alumínio para perfis de canal europeu. Dobradiça tripla para assegurar a mais elevada performance aos mais exigentes requisitos.

ES Bisagra en aluminio para perfiles de canal europeo. Desarrollada para soportar cargas elevadas. Eje en inox 304. Perno de seguridad. Permite regulación 2D.

UK Aluminium hinge for european groove. Triple shape aluminium hinge, specially developed to ensure the best performance in the most demanding situations. 304 stainless steel axle and security pin. 2D regulation.

FR Paumelle en aluminium pour gorge européenne. 3 lames en aluminium. Développé pour garantir la plus haute performance pour les applications les plus exigeantes. Axe en inox 304. Système de réglage 2D.

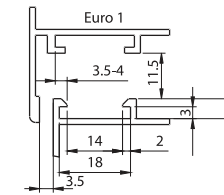
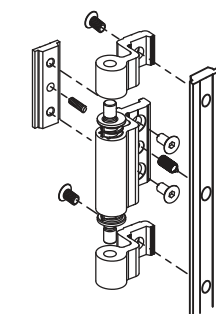
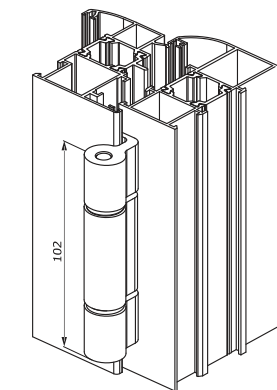

Made in Portugal